

Power Schottky rectifier

Features

- High junction temperature capability
- Optimized trade-off between leakage current and forward voltage drop
- Low leakage current
- Avalanche capability specified
- Insulated package TO-220FPAB
 - insulated voltage: 2000 V
 - package capacitance: 45 pF

Description

This dual diode Schottky rectifier is suited for high frequency switch mode power supply.

Packaged in TO-220AB, I²PAK, D²PAK and TO-220FPAB, this device is particularly suited for use in notebook, game station, LCD TV and desktop adapters, providing these applications with a good efficiency at both low and high load.

Table 1. Device summary

| Symbol | Value |
|-------------|-----------|
| $I_{F(AV)}$ | 2 x 7.5 A |
| V_{RRM} | 80 V |
| T_j (max) | 175 °C |
| V_F (typ) | 485 mV |

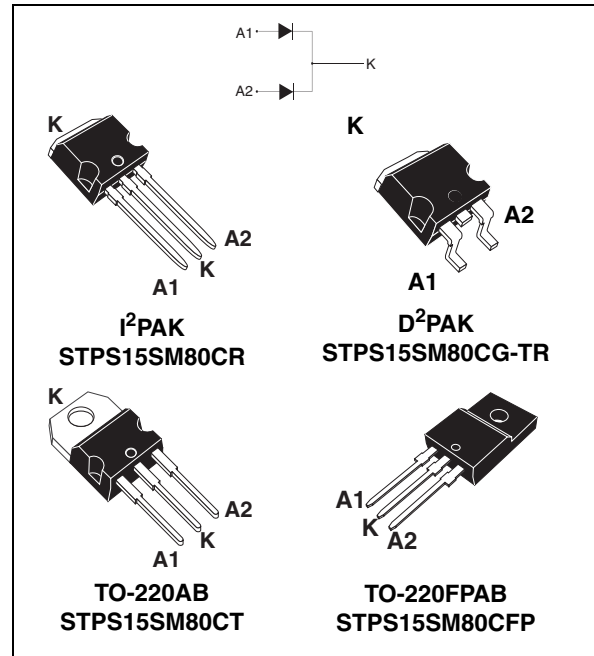
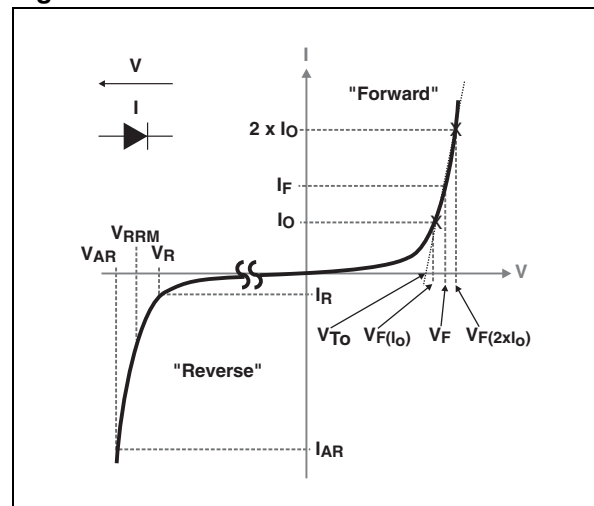

Figure 1. Electrical characteristics (a)



- a. V_{ARM} and I_{ARM} must respect the reverse safe operating area defined in [Figure 13](#). V_{AR} and I_{AR} are pulse measurements ($t_p < 1 \mu s$). V_R , I_R , V_{RRM} and V_F are static characteristics

1 Characteristics

Table 2. Absolute ratings (limiting values, per diode, at $T_{amb} = 25\text{ °C}$ unless otherwise specified)

| Symbol | Parameter | | | Value | Unit | |
|-----------------|---|---|---|-------------------------|-----------|---|
| V_{RRM} | Repetitive peak reverse voltage | | | 80 | V | |
| $I_{F(RMS)}$ | Forward rms current | | | 30 | A | |
| $I_{F(AV)}$ | Average forward current, $\delta = 0.5$ | TO-220AB, I ² PAK, D ² PAK | $T_c = 155\text{ °C}$ $T_c = 150\text{ °C}$ | Per diode Per device | 7.5 15 | A |
| | | TO-220FPAB | $T_c = 140\text{ °C}$ $T_c = 115\text{ °C}$ | Per diode Per device | 7.5 15 | |
| I_{FSM} | Surge non repetitive forward current | $t_p = 10\text{ ms}$ sinusoidal | | $T_c = 25\text{ °C}$ | 150 | A |
| $P_{ARM}^{(1)}$ | Repetitive peak avalanche power | | $T_j = 25\text{ °C}$, $t_p = 1\text{ }\mu\text{s}$ | 4000 | W | |
| $V_{ARM}^{(2)}$ | Maximum repetitive peak avalanche voltage | $t_p < 1\text{ }\mu\text{s}$, $T_j < 150\text{ °C}$, $I_{AR} < 12\text{ A}$ | | 100 | V | |
| $V_{ASM}^{(2)}$ | Maximum single pulse peak avalanche voltage | $t_p < 1\text{ }\mu\text{s}$, $T_j < 150\text{ °C}$, $I_{AR} < 12\text{ A}$ | | 100 | V | |
| T_{stg} | Storage temperature range | | | -65 to +175 | °C | |
| T_j | Maximum operating junction temperature ⁽³⁾ | | | 175 | °C | |

1. For temperature or pulse time duration deratings, please refer to figure 3 and 4. More details regarding the avalanche energy measurements and diode validation in the avalanche are provided in the application notes AN1768 and AN2025.
2. See [Figure 13](#)
3. $\frac{dP_{tot}}{dT_j} < \frac{1}{R_{th(j-a)}}$ condition to avoid thermal runaway for a diode on its own heatsink

Table 3. Thermal parameters

| Symbol | Parameter | | Value | Unit | |
|---------------|------------------|--|------------|-----------|------|
| $R_{th(j-c)}$ | Junction to case | TO-220AB | per diode | 3.10 | °C/W |
| | | I ² PAK, D ² PAK | total | 1.88 | |
| | | | TO-220FPAB | per diode | |
| | | | total | 4.75 | |
| $R_{th(c)}$ | Coupling | TO-220AB I ² PAK, D ² PAK | | 0.65 | °C/W |
| | | TO-220FPAB | | 3.60 | |

When the two diodes 1 and 2 are used simultaneously:

$$\Delta T_j(\text{diode 1}) = P(\text{diode 1}) \times R_{th(j-c)}(\text{Per diode}) + P(\text{diode 2}) \times R_{th(c)}$$

Table 4. Static electrical characteristics (per diode)

| Symbol | Parameter | Test conditions | | Min. | Typ. | Max. | Unit |
|-------------|-------------------------|-----------------------------------|----------------------|------|-------|-------|---------------|
| $I_R^{(1)}$ | Reverse leakage current | $T_j = 25\text{ }^\circ\text{C}$ | $V_R = V_{RRM}$ | - | 4 | 20 | μA |
| | | $T_j = 125\text{ }^\circ\text{C}$ | | - | 3.5 | 15 | mA |
| $V_F^{(2)}$ | Forward voltage drop | $T_j = 25\text{ }^\circ\text{C}$ | $I_F = 3\text{ A}$ | - | 0.550 | 0.600 | V |
| | | $T_j = 125\text{ }^\circ\text{C}$ | | - | 0.485 | 0.520 | |
| | | $T_j = 25\text{ }^\circ\text{C}$ | $I_F = 7.5\text{ A}$ | - | 0.710 | 0.780 | |
| | | $T_j = 125\text{ }^\circ\text{C}$ | | - | 0.600 | 0.660 | |
| | | $T_j = 25\text{ }^\circ\text{C}$ | $I_F = 15\text{ A}$ | - | 0.860 | 0.955 | |
| | | $T_j = 125\text{ }^\circ\text{C}$ | | - | 0.690 | 0.780 | |

1. Pulse test: $t_p = 5\text{ ms}$, $\delta < 2\%$

2. Pulse test: $t_p = 380\text{ }\mu\text{s}$, $\delta < 2\%$

To evaluate the conduction losses use the following equation:

$$P = 0.540 \times I_{F(AV)} + 0.016 \times I_{F(RMS)}^2$$

Figure 2. Average forward power dissipation versus average forward current (per diode)

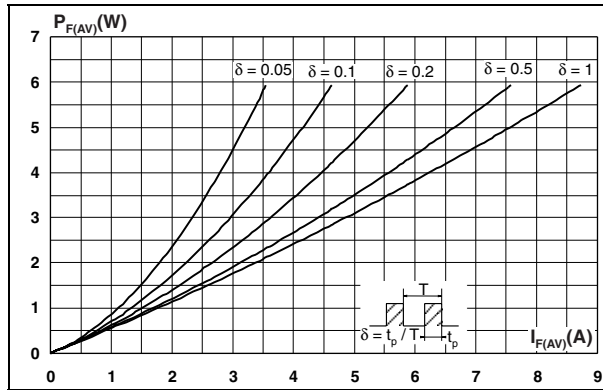

Figure 3. Average forward current versus ambient temperature (delta = 0.5, per diode)

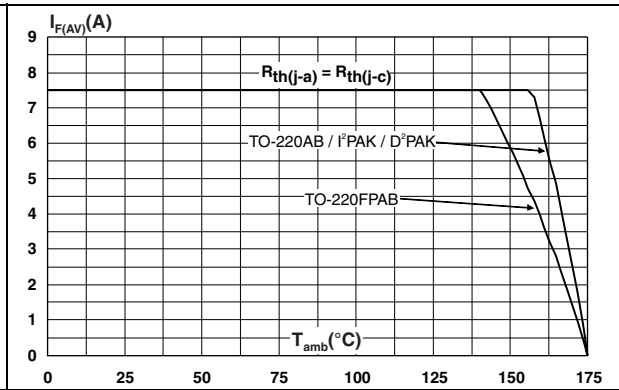

Figure 4. Normalized avalanche power derating versus pulse duration

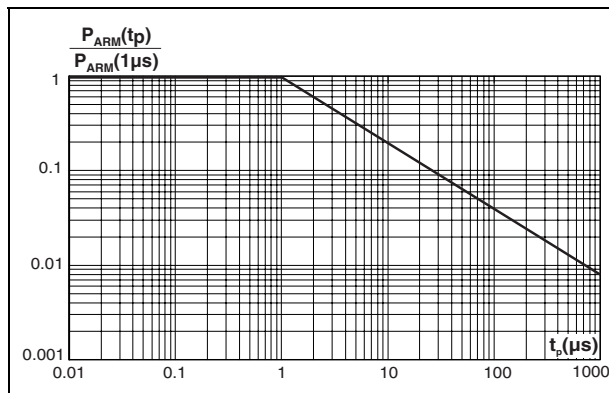

Figure 5. Normalized avalanche power derating versus junction temperature

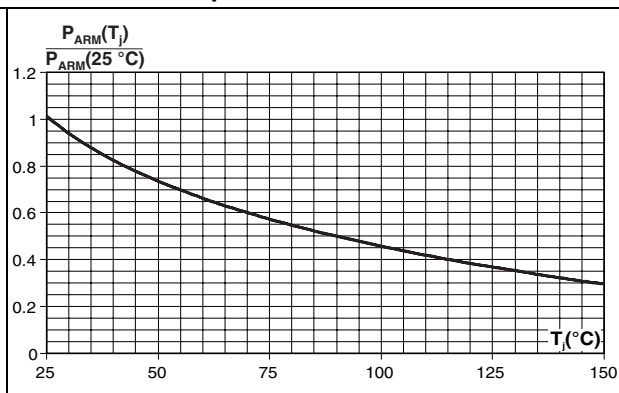

Figure 6. Non repetitive surge peak forward current versus overload duration (maximum values, per diode)

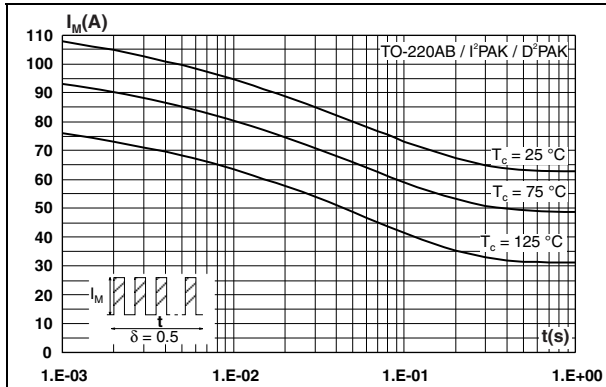

Figure 7. Non repetitive surge peak forward current versus overload duration (maximum values, per diode)

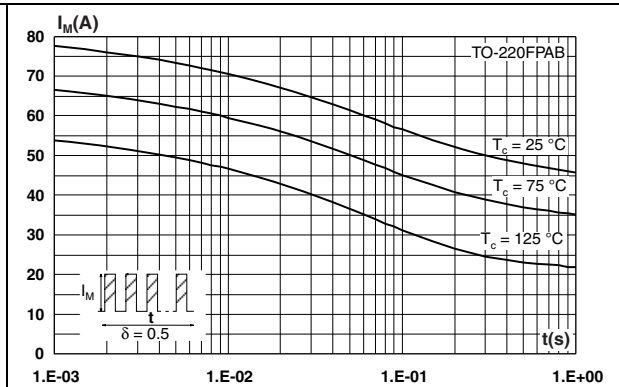

Figure 8. Relative thermal impedance junction to case versus pulse duration

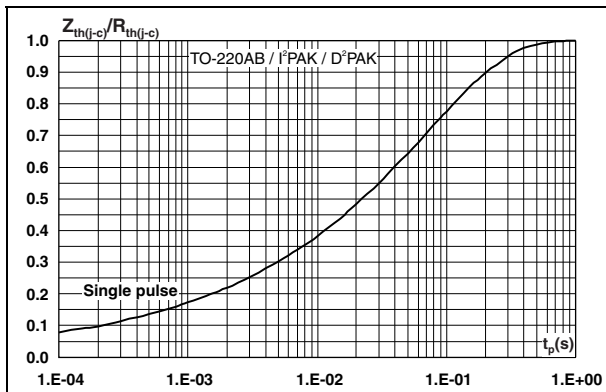

Figure 9. Relative thermal impedance junction to case versus pulse duration (TO-220FPAB)

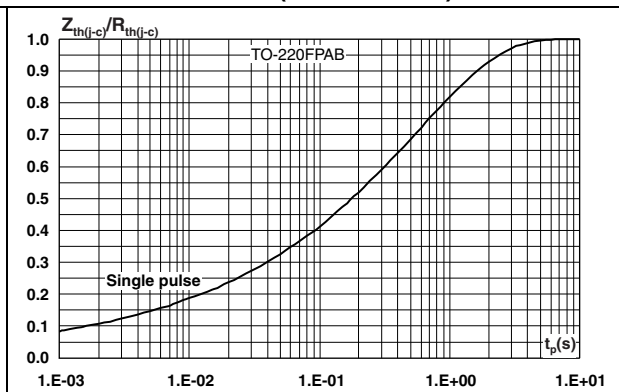

Figure 10. Reverse leakage current versus reverse voltage applied (typical values, per diode)

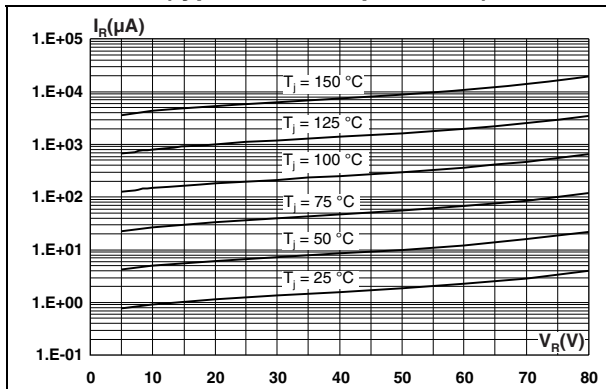

Figure 11. Junction capacitance versus reverse voltage applied (typical values, per diode)

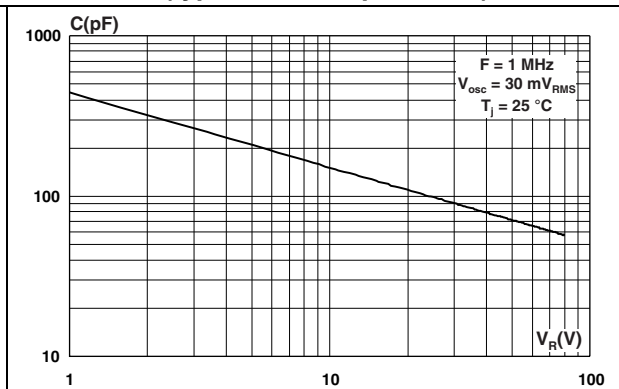

Figure 12. Forward voltage drop versus forward current (per diode)

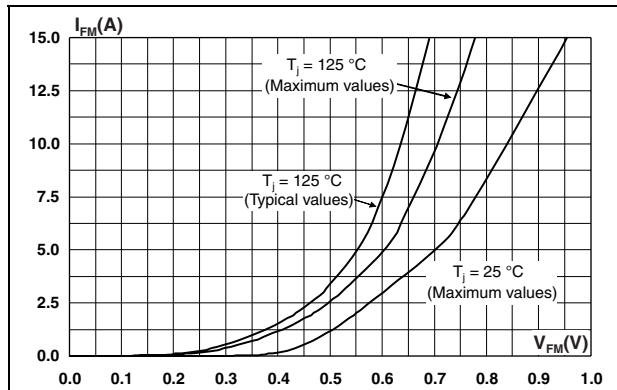

Figure 13. Reverse safe operating area ($t_p < 1\text{ }\mu\text{s}$ and $T_j < 150\text{ °C}$)

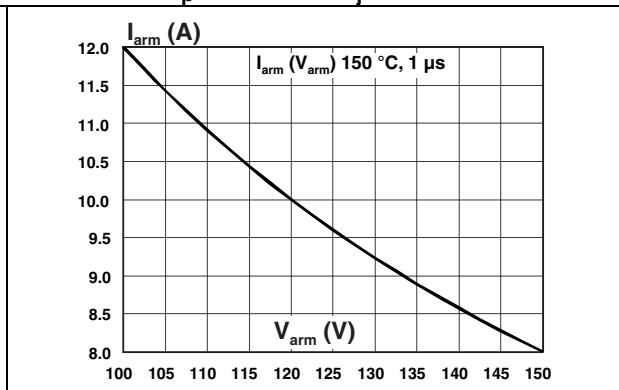
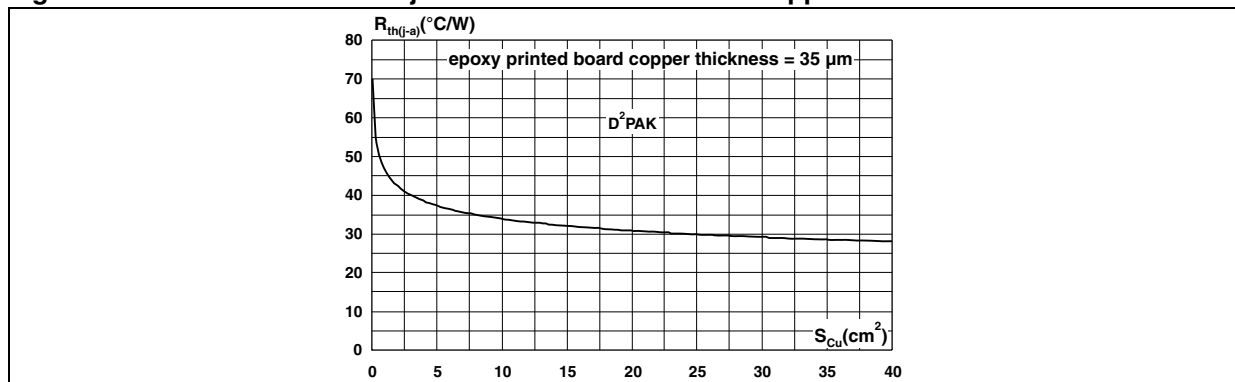

Figure 14. Thermal resistance junction to ambient versus copper surface under tab for D²PAK



2 Package information

- Epoxy meets UL94, V0
- Cooling method: by conduction (C)
- Recommended torque value: 0.4 to 0.6 N·m

In order to meet environmental requirements, ST offers these devices in different grades of ECOPACK® packages, depending on their level of environmental compliance. ECOPACK® specifications, grade definitions and product status are available at: www.st.com. ECOPACK® is an ST trademark.

Table 5. TO-220AB dimensions

| Ref. | Dimensions | | | |
|------|-------------|-------|------------|-------|
| | Millimeters | | Inches | |
| | Min. | Max. | Min. | Max. |
| A | 4.40 | 4.60 | 0.173 | 0.181 |
| C | 1.23 | 1.32 | 0.048 | 0.051 |
| D | 2.40 | 2.72 | 0.094 | 0.107 |
| E | 0.49 | 0.70 | 0.019 | 0.027 |
| F | 0.61 | 0.88 | 0.024 | 0.034 |
| F1 | 1.14 | 1.70 | 0.044 | 0.066 |
| F2 | 1.14 | 1.70 | 0.044 | 0.066 |
| G | 4.95 | 5.15 | 0.194 | 0.202 |
| G1 | 2.40 | 2.70 | 0.094 | 0.106 |
| H2 | 10 | 10.40 | 0.393 | 0.409 |
| L2 | 16.4 Typ. | | 0.645 Typ. | |
| L4 | 13 | 14 | 0.511 | 0.551 |
| L5 | 2.65 | 2.95 | 0.104 | 0.116 |
| L6 | 15.25 | 15.75 | 0.600 | 0.620 |
| L7 | 6.20 | 6.60 | 0.244 | 0.259 |
| L9 | 3.50 | 3.93 | 0.137 | 0.154 |
| M | 2.6 Typ. | | 0.102 Typ. | |
| Dia. | 3.75 | 3.85 | 0.147 | 0.151 |

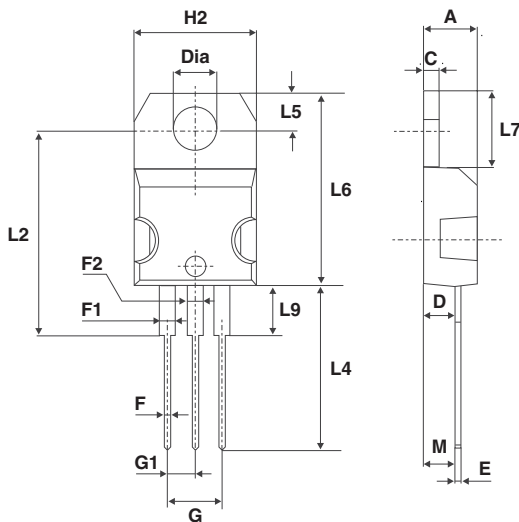

Table 6. TO-220FPAB dimensions

| Ref. | Dimensions | | | |
|------|-------------|------|------------|-------|
| | Millimeters | | Inches | |
| | Min. | Max. | Min. | Max. |
| A | 4.4 | 4.9 | 0.173 | 0.192 |
| B | 2.5 | 2.9 | 0.098 | 0.114 |
| D | 2.45 | 2.75 | 0.096 | 0.108 |
| E | 0.4 | 0.7 | 0.016 | 0.028 |
| F | 0.6 | 1 | 0.024 | 0.039 |
| F1 | 1.15 | 1.7 | 0.045 | 0.067 |
| F2 | 1.15 | 1.7 | 0.045 | 0.067 |
| G | 4.95 | 5.2 | 0.195 | 0.205 |
| G1 | 2.4 | 2.7 | 0.094 | 0.106 |
| H | 10 | 10.7 | 0.394 | 0.421 |
| L2 | 16 Typ. | | 0.630 Typ. | |
| L3 | 28.6 | 30.6 | 1.126 | 1.205 |
| L4 | 9.8 | 10.7 | 0.386 | 0.421 |
| L6 | 15.8 | 16.4 | 0.622 | 0.646 |
| L7 | 9 | 9.9 | 0.354 | 0.390 |
| Dia. | 2.9 | 3.5 | 0.114 | 0.138 |

Table 7. D²PAK dimensions

| Ref. | Dimensions | | | |
|------|-------------|-------|------------|-------|
| | Millimeters | | Inches | |
| | Min. | Max. | Min. | Max. |
| A | 4.40 | 4.60 | 0.173 | 0.181 |
| A1 | 2.49 | 2.69 | 0.098 | 0.106 |
| A2 | 0.03 | 0.23 | 0.001 | 0.009 |
| B | 0.70 | 0.93 | 0.027 | 0.037 |
| B2 | 1.14 | 1.70 | 0.045 | 0.067 |
| C | 0.45 | 0.60 | 0.017 | 0.024 |
| C2 | 1.23 | 1.36 | 0.048 | 0.054 |
| D | 8.95 | 9.35 | 0.352 | 0.368 |
| E | 10.00 | 10.40 | 0.393 | 0.409 |
| G | 4.88 | 5.28 | 0.192 | 0.208 |
| L | 15.00 | 15.85 | 0.590 | 0.624 |
| L2 | 1.27 | 1.40 | 0.050 | 0.055 |
| L3 | 1.40 | 1.75 | 0.055 | 0.069 |
| M | 2.40 | 3.20 | 0.094 | 0.126 |
| R | 0.40 typ. | | 0.016 typ. | |
| V2 | 0° | 8° | 0° | 8° |

Figure 15. D²PAK footprint (dimensions in mm)

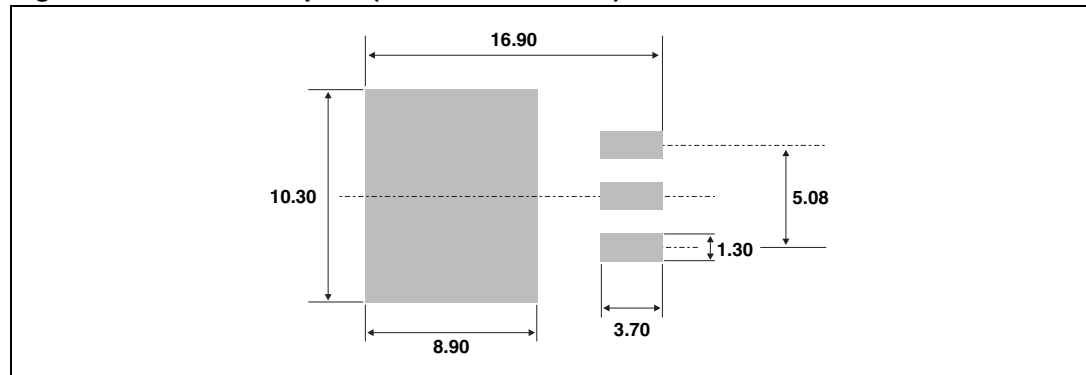

Table 8. I²PAK dimensions

| Ref. | Dimensions | | | |
|------|-------------|-------|--------|-------|
| | Millimeters | | Inches | |
| | Min. | Max. | Min. | Max. |
| A | 4.40 | 4.60 | 0.173 | 0.181 |
| A1 | 2.40 | 2.72 | 0.094 | 0.107 |
| b | 0.61 | 0.88 | 0.024 | 0.035 |
| b1 | 1.14 | 1.70 | 0.044 | 0.067 |
| c | 0.49 | 0.70 | 0.019 | 0.028 |
| c2 | 1.23 | 1.32 | 0.048 | 0.052 |
| D | 8.95 | 9.35 | 0.352 | 0.368 |
| e | 2.40 | 2.70 | 0.094 | 0.106 |
| e1 | 4.95 | 5.15 | 0.195 | 0.203 |
| E | 10 | 10.40 | 0.394 | 0.409 |
| L | 13 | 14 | 0.512 | 0.551 |
| L1 | 3.50 | 3.93 | 0.138 | 0.155 |
| L2 | 1.27 | 1.40 | 0.050 | 0.055 |

3 Ordering information

Table 9. Ordering information

| Order code | Marking | Package | Weight | Base qty | Delivery mode |
|-----------------|-------------|--------------------|--------|----------|---------------|
| STPS15SM80CT | PS15SM80CT | TO-220AB | 1.9 g | 50 | Tube |
| STPS15SM80CFP | PS15SM80CFP | TO-220FPAB | 2.0 g | 50 | Tube |
| STPS15SM80CR | PS15SM80CR | I ² PAK | 1.49 g | 50 | Tube |
| STPS15SM80CG-TR | PS15SM80CG | D ² PAK | 1.48 g | 1000 | Tape and reel |

4 Revision history

Table 10. Revision history

| Date | Revision | Changes |
|-------------|----------|--------------|
| 14-Apr-2011 | 1 | First issue. |

Please Read Carefully:

Information in this document is provided solely in connection with ST products. STMicroelectronics NV and its subsidiaries ("ST") reserve the right to make changes, corrections, modifications or improvements, to this document, and the products and services described herein at any time, without notice.

All ST products are sold pursuant to ST's terms and conditions of sale.

Purchasers are solely responsible for the choice, selection and use of the ST products and services described herein, and ST assumes no liability whatsoever relating to the choice, selection or use of the ST products and services described herein.

No license, express or implied, by estoppel or otherwise, to any intellectual property rights is granted under this document. If any part of this document refers to any third party products or services it shall not be deemed a license grant by ST for the use of such third party products or services, or any intellectual property contained therein or considered as a warranty covering the use in any manner whatsoever of such third party products or services or any intellectual property contained therein.

UNLESS OTHERWISE SET FORTH IN ST'S TERMS AND CONDITIONS OF SALE ST DISCLAIMS ANY EXPRESS OR IMPLIED WARRANTY WITH RESPECT TO THE USE AND/OR SALE OF ST PRODUCTS INCLUDING WITHOUT LIMITATION IMPLIED WARRANTIES OF MERCHANTABILITY, FITNESS FOR A PARTICULAR PURPOSE (AND THEIR EQUIVALENTS UNDER THE LAWS OF ANY JURISDICTION), OR INFRINGEMENT OF ANY PATENT, COPYRIGHT OR OTHER INTELLECTUAL PROPERTY RIGHT.

UNLESS EXPRESSLY APPROVED IN WRITING BY AN AUTHORIZED ST REPRESENTATIVE, ST PRODUCTS ARE NOT RECOMMENDED, AUTHORIZED OR WARRANTED FOR USE IN MILITARY, AIR CRAFT, SPACE, LIFE SAVING, OR LIFE SUSTAINING APPLICATIONS, NOR IN PRODUCTS OR SYSTEMS WHERE FAILURE OR MALFUNCTION MAY RESULT IN PERSONAL INJURY, DEATH, OR SEVERE PROPERTY OR ENVIRONMENTAL DAMAGE. ST PRODUCTS WHICH ARE NOT SPECIFIED AS "AUTOMOTIVE GRADE" MAY ONLY BE USED IN AUTOMOTIVE APPLICATIONS AT USER'S OWN RISK.

Resale of ST products with provisions different from the statements and/or technical features set forth in this document shall immediately void any warranty granted by ST for the ST product or service described herein and shall not create or extend in any manner whatsoever, any liability of ST.

ST and the ST logo are trademarks or registered trademarks of ST in various countries.

Information in this document supersedes and replaces all information previously supplied.

The ST logo is a registered trademark of STMicroelectronics. All other names are the property of their respective owners.

© 2011 STMicroelectronics - All rights reserved

STMicroelectronics group of companies

Australia - Belgium - Brazil - Canada - China - Czech Republic - Finland - France - Germany - Hong Kong - India - Israel - Italy - Japan - Malaysia - Malta - Morocco - Philippines - Singapore - Spain - Sweden - Switzerland - United Kingdom - United States of America

www.st.com